

Electronic timer CT-ERE

ON-delayed with 1 c/o (SPDT) contact

The CT-ERE is an electronic time relay with ON-delay. It is from the CT-E range.

The CT-E range is the economic range of ABB's time relays and offers a cost effective price-performance ratio for OEM users. This is achieved by simplified functionality and results in the simplest of setup procedures. The CT-E range is ideally suited for repeat applications.



1SVR 550 107 F4100

Characteristics

- 8 versions:
 - 4 different single time ranges (0.1-10 s, 0.3-30 s, 3-300 s and 0,3-30 min) and
 - 2 different rated control supply voltage ranges (24 V AC/DC / 220-240 V AC and 110-130 V AC)
- Single-function ON-delay timer
- 1 c/o (SPDT) contact
- 22.5 mm (0.89 in) width
- 2 LEDs for the indication of operational states

Order data

Type	Rated control supply voltage	Time range	Order code
CT-ERE	24 V AC/DC, 220-240 V AC	0,1-10 s	1SVR 550 107 R1100
		0,3-30 s	1SVR 550 107 R4100
		3-300 s	1SVR 550 107 R2100
		0,3-30 min	1SVR 550 107 R5100
	110-130 V AC	0,1-10 s	1SVR 550 100 R1100
		0,3-30 s	1SVR 550 100 R4100
		3-300 s	1SVR 550 100 R2100
		0,3-30 min	1SVR 550 100 R5100

Functions

Operating controls

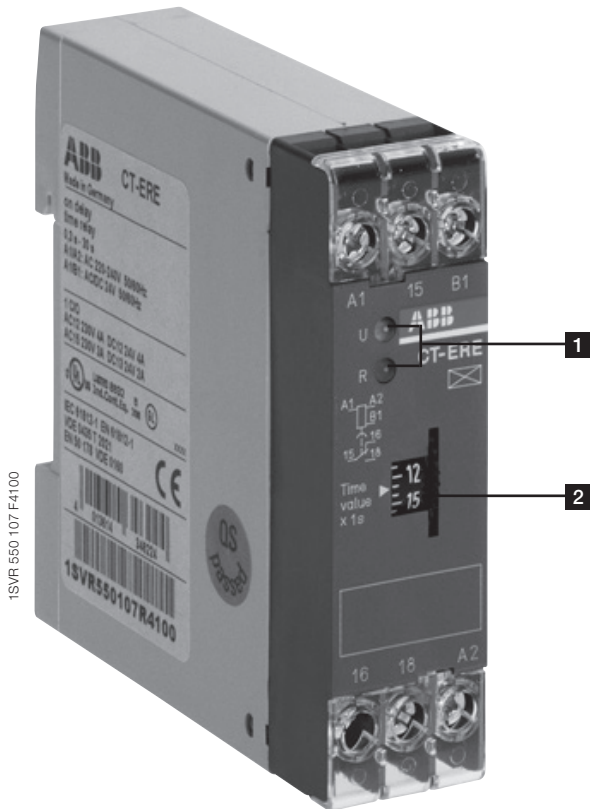

1 Indication of operational states

U: green LED – Control supply voltage applied

R: red LED – Output relay energized

2 Thumbwheel for the fine adjustment of the time delay

Application

Their conception makes the CT-E range timers ideal for repeat applications.

Operating mode

The fine adjustment of the time delay is made via the front-face thumbwheel.

Function diagram

☒ ON-delay (Delay on make)

Applying control supply voltage starts timing. When the selected time delay is complete, the output relay energizes. If control supply voltage is interrupted, the output relay de-energizes and the time delay is reset. Interrupting control supply voltage before the time delay is complete, resets the time delay. The output relay does not energize.

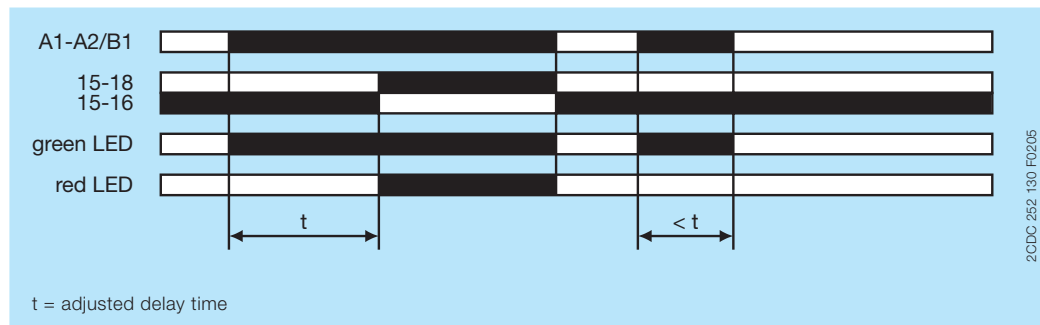

Electrical connection

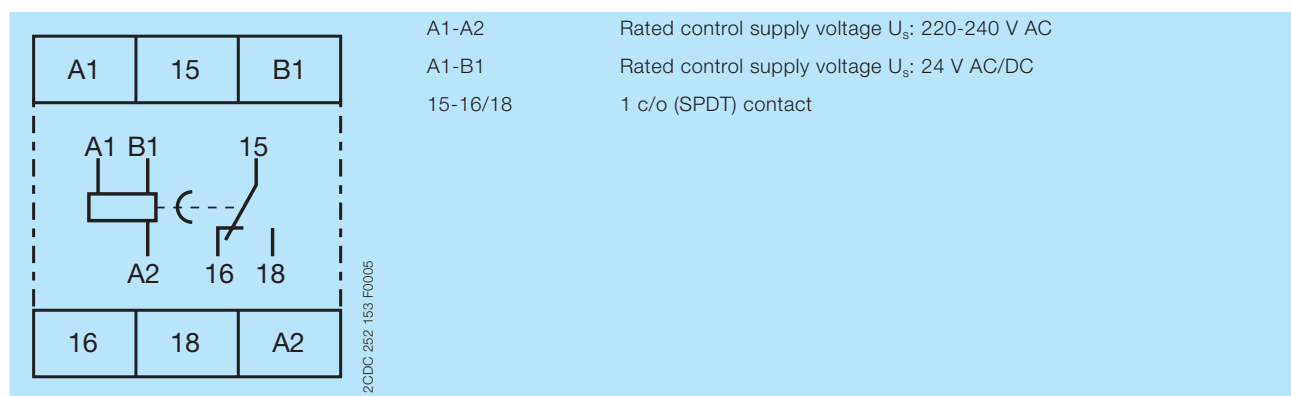

Connection diagram

1SVR 550 107 R1100, 1SVR 550 107 R4100, 1SVR 550 107 R2100, 1SVR 550 107 R5100

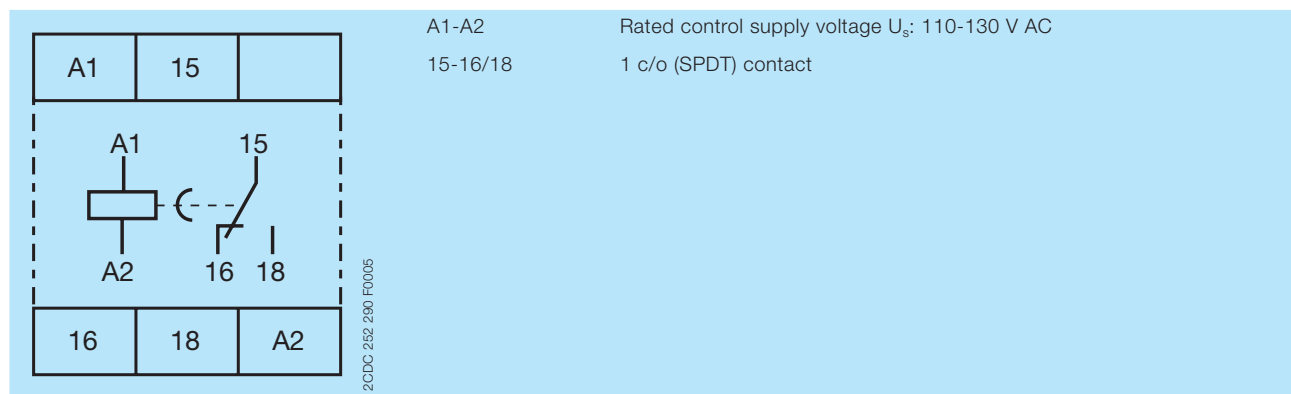

Connection diagram

1SVR 550 100 R1100, 1SVR 550 100 R4100, 1SVR 550 100 R2100, 1SVR 550 100 R5100

Technical data



Data at $T_a = 25\text{ °C}$ and rated values, unless otherwise indicated

Input circuits

Supply circuit		
Rated control supply voltage U_s	A1-A2	220-240 V AC
	A1-A2	110-130 V AC
	A1-B1	24 V AC/DC
Rated control supply voltage U_s tolerance		-15...+10 %
Rated frequency	AC/DC version	DC or 50/60 Hz
	AC version	50/60 Hz
Typical current / power consumption	24 V AC/DC	approx. 1.0 VA/W
	110-130 V AC	approx. 2.0 VA
	220-240 V AC	approx. 2.0 VA
Release voltage		> 10 % of the minimum control supply voltage

Timing circuit	
Time range	depending on device: 0.1-10 s. 0.3-30 s. 3-300 s or 0.3-30 min
Recovery time	< 50 ms
Repeat accuracy (constant parameters)	$\Delta t < 1\%$
Accuracy within the rated control supply voltage tolerance	$\Delta t < 0.5\% / V$
Accuracy within the temperature range	$\Delta t < 0.1\% / \text{°C}$
Setting accuracy of time delay	$\pm 10\%$ of full-scale value

User interface

Indication of operational states		
Control supply voltage	U: green LED	 : control supply voltage applied
Relay status	R: red LED	 : output relay energized

Output circuit

Kind of output	15-16/18	relay, 1 c/o (SPDT) contact
Contact material		silver alloy
Rated operational voltage U_s		250 V
Minimum switching voltage / current		12 V / 100 mA
Maximum switching voltage / current		see 'Load limit curves'
Rated operational current I_e	AC-12 (resistive) at 230 V	4 A
	AC-15 (inductive) at 230 V	3 A
	DC-12 (resistive) at 24 V	4 A
	DC-13 (inductive) at 24 V	2 A
AC rating (UL 508)	Utilization category (Control Circuit Rating Code)	B 300
	max. rated operational voltage	300 V AC
	Maximum continuous thermal current at B300	5 A
	max. making/breaking apparent power at B300	3600 VA / 360 VA
Mechanical lifetime		10×10^6 switching cycles
Electrical lifetime	AC-12, 230 V, 4 A	0.1×10^6 switching cycles
Frequency of operation	with/without load	$360/72000^{-1}$
Maximum fuse rating to achieve short-circuit protection	n/c contact	10 A fast
	n/o contact	10 A fast

General data

MTBF	on request		
Duty time	100 %		
Dimensions	see 'Dimensional drawings'		
Weight	net weight	1SVR550107R1100	0.067 kg (0.148 lb)
		1SVR550107R4100	0.067 kg (0.148 lb)
		1SVR550107R2100	0.067 kg (0.148 lb)
		1SVR550107R5100	0.067 kg (0.148 lb)
		1SVR550100R1100	0.057 kg (0.126 lb)
		1SVR550100R4100	0.065 kg (0.143 lb)
		1SVR550100R2100	0.057 kg (0.126 lb)
	gross weight	1SVR550107R1100	0.078 kg (0.172 lb)
		1SVR550107R4100	0.078 kg (0.172 lb)
		1SVR550107R2100	0.078 kg (0.172 lb)
		1SVR550107R5100	0.078 kg (0.172 lb)
		1SVR550100R1100	0.068 kg (0.150 lb)
		1SVR550100R4100	0.076 kg (0.168 lb)
		1SVR550100R2100	0.068 kg (0.150 lb)
	1SVR550100R5100	0.076 kg (0.168 lb)	
Mounting	DIN rail (IEC/EN 60715), snap-on mounting without any tool		
Mounting position	any		
Minimum distance to other units	not necessary		
Material of housing	lower section	UL 94 V-0	
	upper section	UL 94 V-2	
Degree of protection	housing	IP50	
	terminals	IP20	

Electrical connection

Connecting capacity	fine-strand with wire end ferrule	2 x 0.75-1.5 mm ² (2 x 18-16 AWG)
	fine-strand without wire end ferrule	2 x 1-1.5 mm ² (2 x 18-16 AWG)
	rigid	2 x 0.75-1.5 mm ² (2 x 18-16 AWG)
Stripping length	10 mm (0.39 in)	
Tightening torque	0.6-0.8 Nm (5.31-7.08 lb.in)	

Environmental data

Ambient temperature ranges	operation	-20...+60 °C
	storage	-40...+85 °C
Relative humidity range	4 x 24 h cycle, 40 °C, 93 % RH	
Vibration, sinusoidal	IEC/EN 60068-2-6	20 m/s ² , 10-58/60-150 Hz
Shock, half-sine	IEC/EN 60068-2-27	150 m/s ² , 11 ms, 3 shocks/direction

Isolation data

Rated insulation voltage U _i	between all isolated circuits	Control supply voltage up to 240 V: 300 V
		Control supply voltage up to 440 V: 500 V
Rated impulse withstand voltage U _{imp}	between all isolated circuits	4 kV / 1.2-50 μs
Power frequency withstand voltage (test voltage)	between all isolated circuits	2.5 kV, 50 Hz, 1 min.
Basic insulation (IEC/EN 61140)	input/output	300 V
Protective separation (IEC/EN 61140, EN 50178)	input/output	-
Pollution degree	3	
Overvoltage category	III	

Standards / Directives

Standards	IEC/EN 61812-1
Low Voltage Directive	2014/35/EU
EMC Directive	2014/30/EU
RoHS Directive	2011/65/EU

Electromagnetic compatibility

Interference immunity to		IEC/EN 61000-6-2
electrostatic discharge	IEC/EN 61000-4-2	Level 3 (6 kV / 8 kV)
radiated, radio-frequency, electromagnetic field	IEC/EN 61000-4-3	10 V/m (1 GHz), 3 V/m (2 GHz), 1 V/m (2.7 GHz)
electrical fast transient / burst surge	IEC/EN 61000-4-4	Level 3 (2 kV / 5 kHz)
surge	IEC/EN 61000-4-5	Level 4 (2 kV L-L)
conducted disturbances, induced by radio-frequency fields	IEC/EN 61000-4-6	Level 3 (10 V)
Interference emission		IEC/EN 61000-6-3
high-frequency radiated	IEC/CISPR 22, EN 55022	Class B
high-frequency conducted	IEC/CISPR 22, EN 55022	Class B

Technical diagrams

Load limit curves

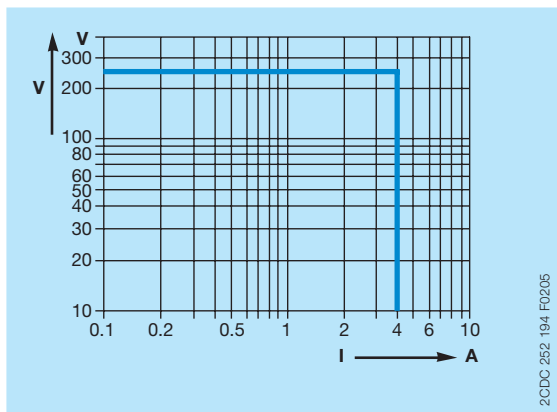

AC load (resistive)

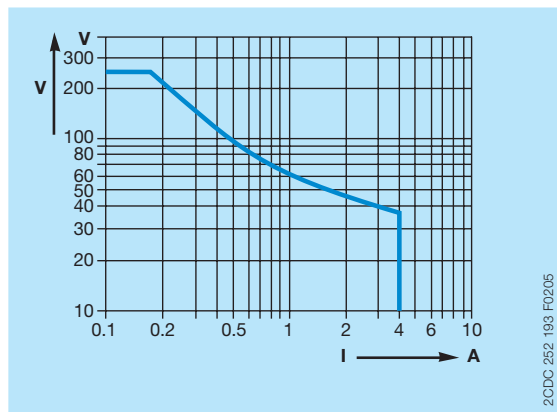

DC load (resistive)

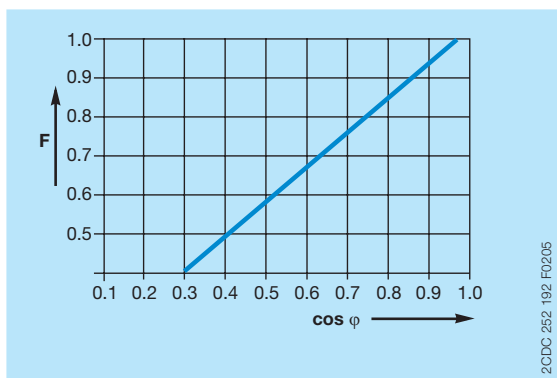

Derating factor F for inductive AC load

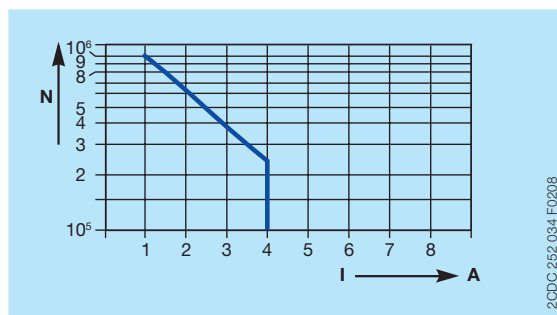

Contact lifetime /switching cycles N
220 V 50 Hz AC1, 360 cycles/h

Dimensions

in **mm** and *inches*

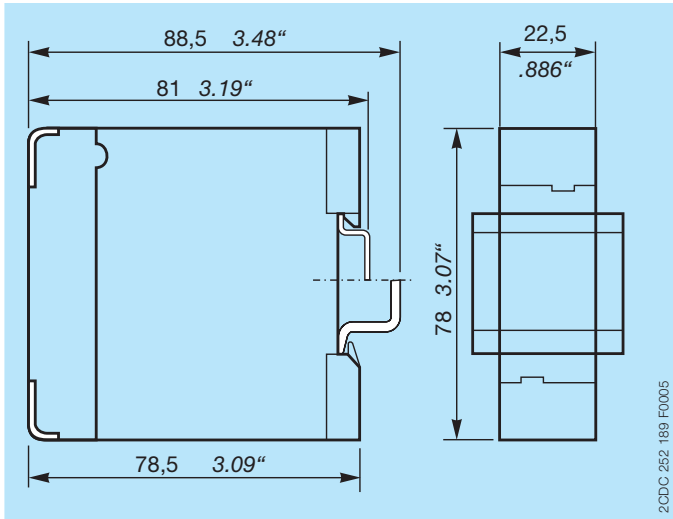

Further documentation

Document title	Document type	Document number
Electronic relays and controls	Catalog	2CDC 110 004 C02xx

You can find the documentation on the internet at www.abb.com/lowvoltage
-> Automation, control and protection -> Electronic relays and controls -> Time relays.

CAD system files

You can find the CAD files for CAD systems at <http://abb-control-products.partcommunity.com>
-> Low Voltage Products & Systems -> Control Products -> Electronic Relays and Controls.

Contact us

ABB STOTZ-KONTAKT GmbH

P. O. Box 10 16 80
69006 Heidelberg, Germany
Phone: +49 (0) 6221 7 01-0
Fax: +49 (0) 6221 7 01-13 25
E-mail: info.desto@de.abb.com

You can find the address of your
local sales organisation on the
ABB home page
<http://www.abb.com/contacts>
-> Low Voltage Products and Systems

Note:

We reserve the right to make technical changes or modify the contents of this document without prior notice. With regard to purchase orders, the agreed particulars shall prevail. ABB AG does not accept any responsibility whatsoever for potential errors or possible lack of information in this document.

We reserve all rights in this document and in the subject matter and illustrations contained therein. Any reproduction, disclosure to third parties or utilization of its contents – in whole or in parts – is forbidden without prior written consent of ABB AG.

Copyright© 2017 ABB
All rights reserved